

LESSON 6

Today's lesson will teach you how to graphically explain the layout of a room in a drawing known as a floor plan. Similar to the elevations we studied last week, floor plans are two-dimensional drawings that use simple geometrical diagrams to explain rooms.

Floor Plan: a drawing used to show the interior spaces of the building and how they relate to each other.

Symbol: a graphic representation of a real life object in a drawing.

Two-dimensional: having only two dimensions such as length and height. Not showing any depth.

A floor plan is an important communication tool between architects and their clients. The floor plans shown on this page are from the Cathedral at Reims, France and a Greek temple called the Parthenon built in the 5th century.

The floor plan for a building can be very simple or very complex depending upon the number of functions in a space and the way the architect wants it. Can you find the walls, columns, and stairs in these plans? What do you think the X's in the Cathedral's plan represent?



PICTORIAL DRAWING

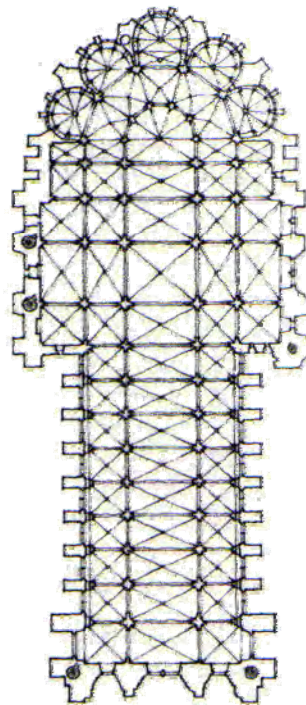
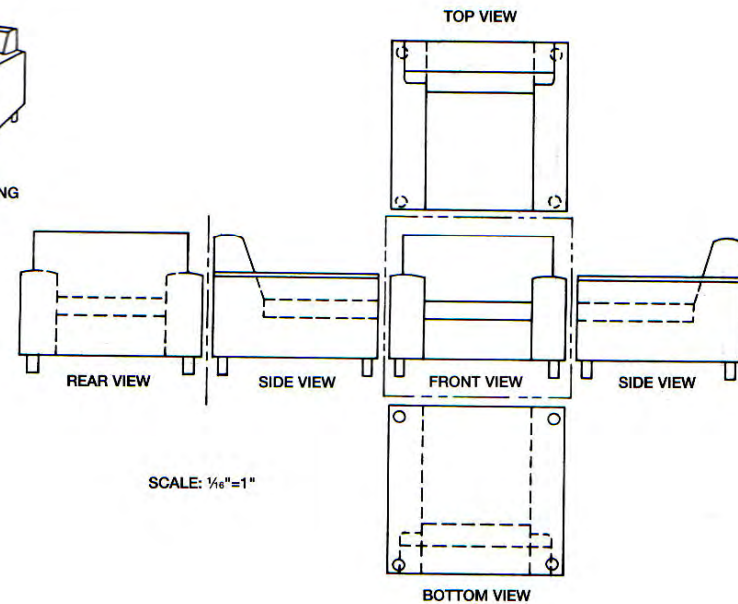

Cathedral at Reims, 1211-1290

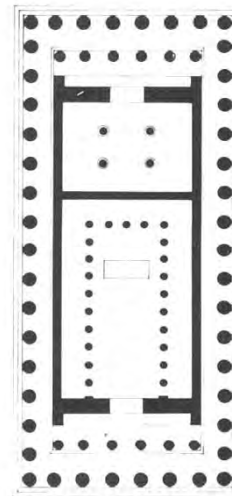

The Parthenon

Cathedral and Chair Drawings by
Francis Ching
Parthenon Plan from Charbonneaux-
Martin-Villard

Floor plans show more than just walls and room sizes. A floor plan also shows the location of windows, doors and sometimes furniture.

Symbols are commonly used by architects to communicate his or her ideas. Some common symbols used are those for doors, windows, furniture and walls.

Assignment:

Try to identify what the symbols shown in the space to the right represent and then recreate the symbols in the space provided.

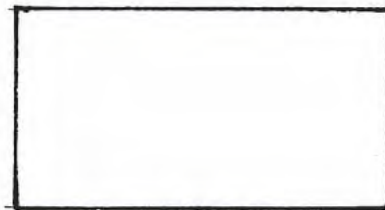
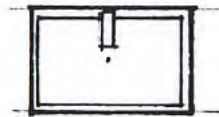
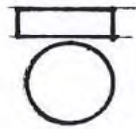
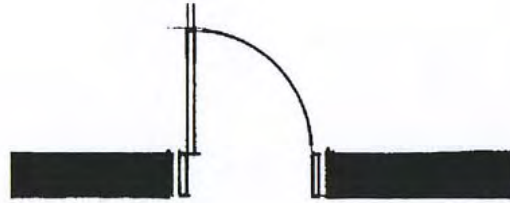
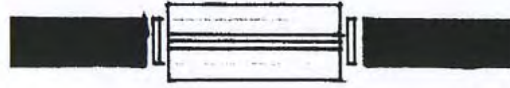

Assignment:

Now that you have practiced drawing some of the different symbols that an architect would use, locate as many symbols as possible on this floor plan of a house and write their names on the plan.

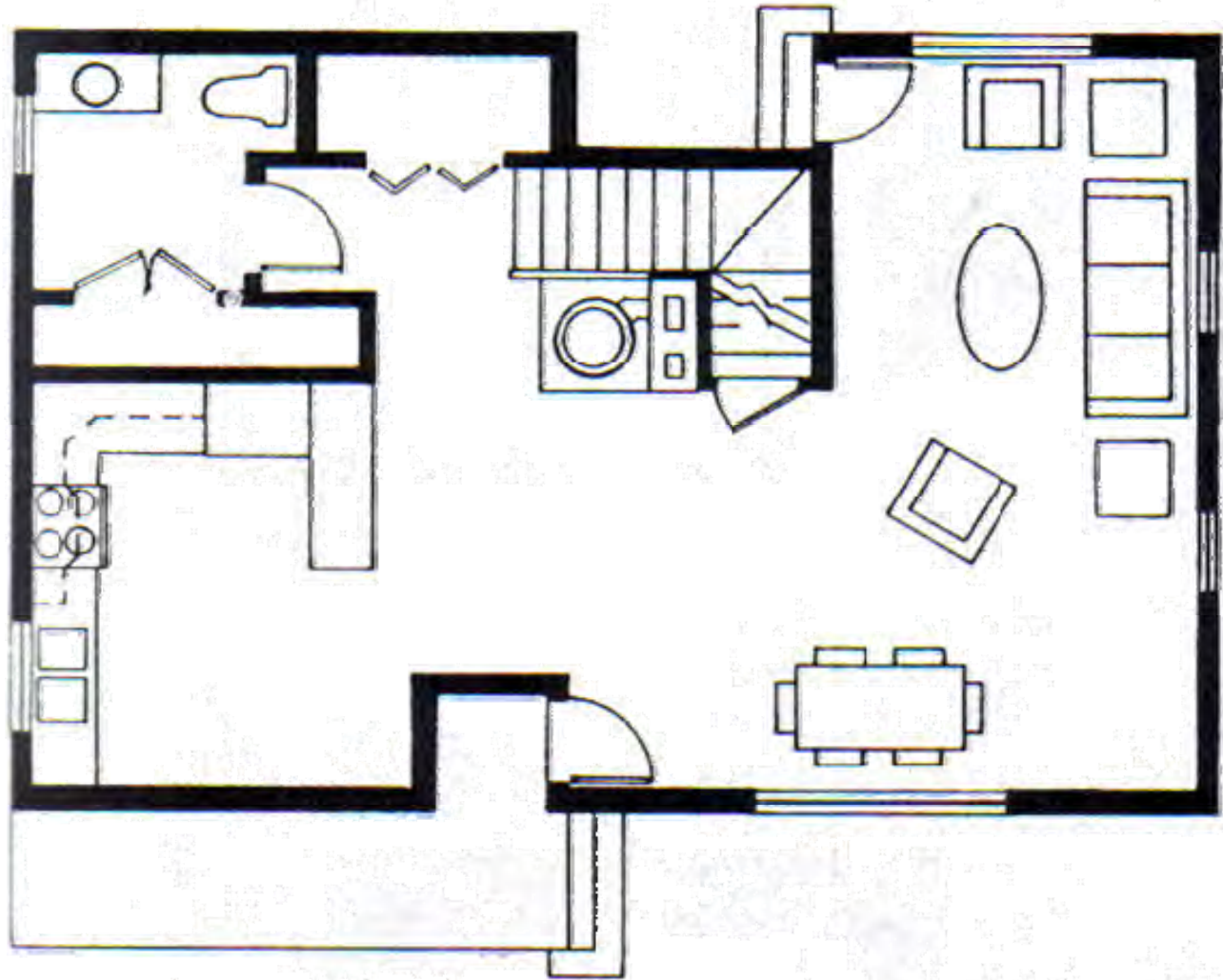

Assignment:

Draw the plan of your classroom in the space provided while your ASTEK leaders are drawing it on the board. Include the walls, windows, doors, desks, and any other furniture that is in your classroom.

Assignment:

Now try to draw the floor plan for the building you are designing for your class' city. How many different rooms do you think your building needs?

Building of the Week:

The Glass House was designed by Philip Johnson in 1949, in New Canaan, Connecticut. Wanting to create a very open [transparent] floor plan, Johnson replaced nearly all the walls with glass. It has been described as “the most beautiful, yet least functional house ever built.”

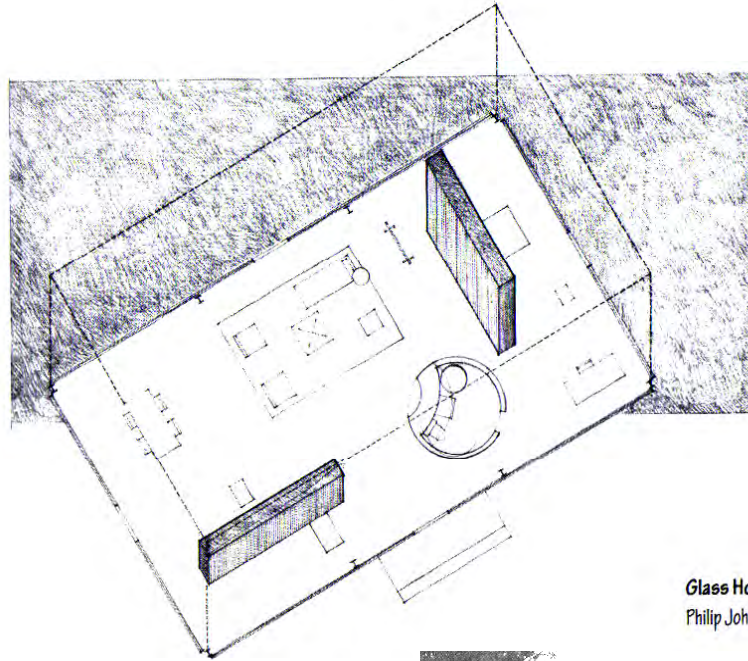

Glass House, New Canaan, Connecticut, 1949,
Philip Johnson



Drawing by Francis Ching